

AIR

Rimadesio



AIR IS A FLOOR-TO-CEILING, DOUBLE-SIDED, BI-DIRECTIONAL SWING DOOR SYSTEM FLUSH WITH THE WALL. THE STRUCTURE HAS BEEN ENGINEERED TO OFFER A WIDE RANGE OF STYLES THAT ARE BOTH AESTHETICALLY PLEASING AND OF THE HIGHEST FUNCTIONAL QUALITY. THE VERSATILE DESIGN OF THE PRODUCT ALLOWS IT TO BE INSTALLED ON THE WALL WITHOUT JAMB OR INTEGRATED IN THE MODULOR PANELLING. IT IS ALWAYS CUSTOM MADE, WITH MAXIMUM DIMENSIONS OF 3600 MM IN HEIGHT AND 1540 MM IN WIDTH.

IT Air è un sistema di porte a bilico bidirezionale a tutta altezza, bifacciale e coplanare alla parete. La struttura è progettata per offrire un'ampia gamma di tipologie estetiche e massima qualità funzionale. La versatilità del prodotto permette l'installazione su parete senza stipite o integrata nella boiserie Modulor. Realizzata sempre su misura, le misure massime raggiungono 3600 mm in altezza e 1540 mm in larghezza.

DE Air ist ein beidseitiges, bidirektionales Drehtürsystem über die volle Höhe und bündig zur Wand. Die Struktur ist darauf ausgelegt, eine breite Palette visueller Typen und ein Maximum an funktionaler Qualität zu bieten. Aufgrund der vielseitigen Verwendbarkeit des Produkts kann es an einer Wand ohne Pfosten angebracht oder in die Modulor-Verkleidung integriert werden. Die stets nach Maß gefertigten Modelle erreichen eine maximale Höhe von 3600 mm und eine Breite von 1540 mm.

FR Air est un système de porte pivotante bidirectionnelle à toute hauteur, double face et coplanaire au mur. La structure est conçue de manière à proposer un large éventail de finitions et une qualité fonctionnelle maximale. La polyvalence de ce produit permet une installation murale sans jambage ou une intégration dans la boiserie Modulor. Toujours réalisé sur mesure, les dimensions maximales sont de 3600 mm en hauteur et 1540 mm en largeur.

ES Air es un sistema de puerta pivotante bidireccional de toda altura, de doble cara y coplanaria a la pared. La estructura está diseñada para ofrecer una amplia gama de tipologías estéticas y la máxima calidad funcional. La versatilidad del producto permite su instalación en pared sin jamba o integrada en el sistema de paneles Modulor. Se realiza siempre a medida; las medidas máximas alcanzan los 3600 mm de alto y los 1540 mm de ancho.

RU Air - это система двусторонних поворотных дверей, выполненных на всю высоту и в одной плоскости со стеной. Конструкция структуры предлагает широкий спектр эстетических решений и максимально функциональное качество. Универсальность изделия позволяет монтировать его в стену без коробки или встраивать в систему стеновых панелей Modulor. Система всегда изготавливается по индивидуальным размерам, максимальные размеры панели достигают 3600 мм в высоту и 1540 мм в ширину.

汉语 Air 是一套双面、全高、与墙共面的双向枢轴门系统。该结构的设计旨在提供多样美感和极佳的功能性品质。这款设计的功能性多元化可安装在没有门套的墙面或嵌入 Modulor 壁板当中。均按尺寸定制, 最大高度可达 3600 毫米、宽度可达 1540 毫米。







AIR REGULAR
Structure: 19 rovere termotrattato
Glass: 63 grigio trasparente, 03 acidato grigio





EN The Air door is available in four design variants: Air, Air regular, Air+ and Air pure, in single or double leaf versions. The aluminium frame is available in noce, rovere, rovere termotrattato, bronzo, grafite, brown or nero finishing. The glass panels can be made in a single finishing, or may include a second finishing for an even more customised look.

IT La porta Air è disponibile in quattro varianti estetiche: Air, Air regular, Air+ e Air pure, previste nelle versioni singola o doppia battente. La struttura in alluminio è prevista in finitura noce, rovere, rovere termotrattato, bronzo, grafite, brown e nero. I vetri possono essere realizzati in un'unica finitura, oppure prevedere l'integrazione di alcuni moduli in una seconda, per una resa estetica ancora più personalizzata.

DE Die Tür Air ist in vier optischen Varianten erhältlich: Air, Air regular, Air+ und Air pure sind in ein- oder zweiflügeliger Ausführung erhältlich. Das Gestell aus Aluminium ist in den Farben Noce, Rovere, Rovere termotrattato, Bronze, Grafite, Brown und Nero erhältlich. Das Glas kann in einer einzigen Oberfläche hergestellt werden, oder einige Module können in einer zweiten integriert werden, um einen noch individuelleren Look zu erzielen.

FR La porte Air est disponible en quatre versions esthétiques: Air, Air regular, Air+ et Air pure, et en version simple ou double battant. La structure en aluminium est disponible dans les finitions noce, rovere, rovere termotrattato, bronzo, grafite, brown et nero. Les éléments en verre peuvent être réalisés en une seule finition, ou être complétés par certains modules dans une deuxième finition, pour un résultat esthétique encore plus personnalisé.

ES La puerta Air está disponible en cuatro variantes estéticas: Air, Air regular, Air+ y Air pure en versiones de una o dos hojas. La estructura de aluminio está disponible en acabados noce, rovere, rovere termotrattato, bronzo, grafite, brown y nero. El cristal se puede fabricar en un solo acabado, o prever la integración de algunos módulos en un segundo acabado, para ofrecer un resultado estético aún más personalizado.

RU Дверь Air представлена четырьмя вариантами внешнего оформления: Air, Air regular, Air + и Air pure в одностворчатом или двустворчатом исполнении. Предлагается отделка алюминиевого каркаса под орех, натуральный или термообработанный дуб, бронзу, графит, а также коричневого и черного цвета. Остекление может быть выполнено с единой отделкой или же в некоторые ячейки можно поставить другой цвет чтобы придать пространству еще большую индивидуальность.

汉语 Air 系列的门提供四种美学版本：Air、Air Regular、Air+ 以及 Air Pure，四者皆可选择平开门或双开门。铝合金结构的表面处理有胡桃木、橡木、热处理橡木、黄铜、石墨、棕与黑可供选择。可为玻璃选择单色的表面处理，亦可为部分区域挑选另一款色彩，以获得更加个性化的外观。



AIR
Structure: 19 rovere termotrattato
Glass: 03 acidato grigio
Handle: 302 grafite, 19 rovere termotrattato



DOORS / AIR



AIR
Structure: 19 rovere termotrattato
Glass: 03 acidato grigio

In this photo
Console: Rialto
Wall panelling system: Modulor



BI-DIRECTIONAL DOOR



BI-DIRECTIONAL DOOR COMBINED WITH MODULOR PANELLING



1. Laminated or tempered glass of 6 mm thickness
2. Door structure in extruded aluminium
3. Modolor terminal filler, available in one-sided and double sided version
4. Modolor wall panelling

TECHNICAL DESCRIPTION

EN The door is always custom made and reaches a maximum height of 3600 mm and a width of 1540 mm. Air pure is also available in a width of 2040 mm with a maximum height of 2949 mm. A hydraulic hinge allows automatic closing of the door at a preset speed, with stops at 0°, +90° and -90°. The hinge is adjustable on the ceiling.

IT Realizzata sempre su misura, la porta raggiunge l'altezza massima di 3600 mm per una larghezza di 1540 mm. Air pure è disponibile anche nella larghezza di 2040 mm vincolata all'altezza 2949 mm. Una cerniera oleodinamica permette la chiusura automatica della porta a velocità preimpostata, con stop a 0°, +90° e -90°. Il cardine è regolabile a soffitto.

DE Die Tür wird stets nach Maß gefertigt und erreicht eine maximale Höhe von 3600 mm und eine Breite von 1540 mm. Air pure ist auch in einer Breite von 2040 mm bei einer Höhe von 2949 mm erhältlich. Ein hydraulisches Scharnier ermöglicht das automatische Schließen der Tür mit einer voreingestellten Geschwindigkeit, mit Anschlägen bei 0°, +90° und -90°. Das Scharnier ist bis zur Decke verstellbar.

FR Toujours réalisée sur mesure, la porte est disponible dans une hauteur maximale de 3600 mm pour une largeur de 1540 mm. Air pure est également disponible dans la largeur 2040 mm et limitée à une hauteur de 2949 mm. Une charnière hydraulique permet la fermeture automatique de la porte à une vitesse prédéfinie, avec des arrêts à 0°, +90° et -90°. La charnière est réglable au plafond.

ES Siempre hecha a medida, la puerta alcanza una altura máxima de 3600 mm para una anchura de 1540 mm. Air pure también está disponible con una anchura de 2040 mm combinada con la altura de 2949 mm. Una bisagra hidráulica permite el cierre automático de la puerta a una velocidad preestablecida, con paradas a 0°, +90° y -90°. La bisagra se ajusta al techo.

RU Дверь всегда изготавливается по индивидуальным размерам, ее максимальные размеры достигают 3600 мм в высоту и 1540 мм в ширину. Вариант Air pure также изготавливается с шириной 2040 мм при высоте 2949 мм. Гидравлическая петля-доводчик позволяет двери закрываться автоматически с заданной скоростью и остановками на 0°, +90° и -90°. Регулируемый шарнир устанавливается на потолке.

汉语 均按尺寸定制, 最高可达 3600 毫米, 最宽可达 1540 毫米。另有宽 2040 毫米、高 2949 毫米的 Air Pure 系列。液压缓冲铰链可使门以预设速度自动关闭, 有 0° +90° -90° 三个停止点。天花板的铰链为可调式。

Bi-directional door without jamb

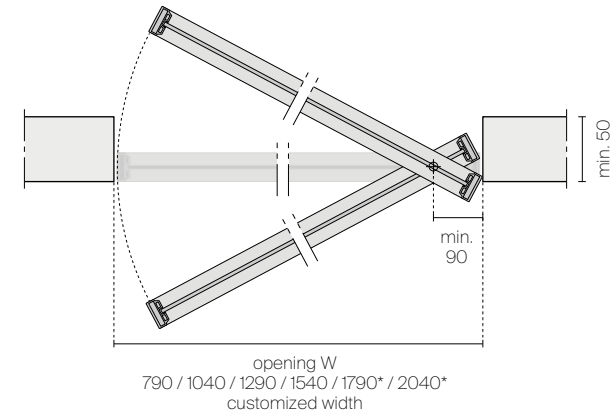
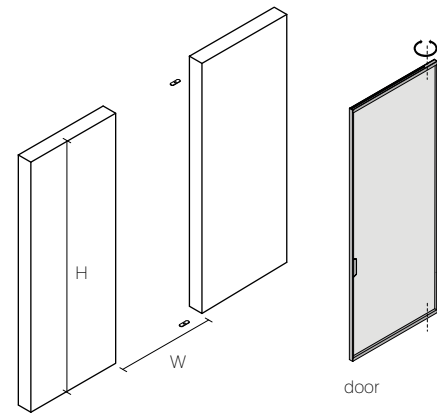

Bi-directional door combined with Modolor panelling

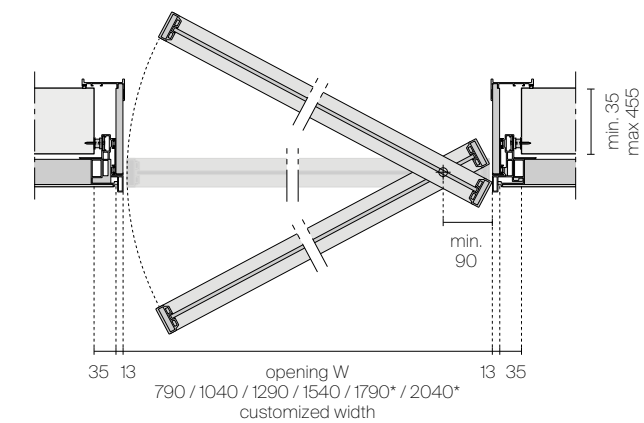
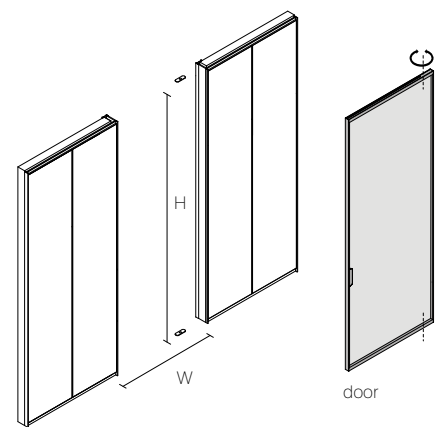

* available only for Air pure

DIMENSIONS

Air

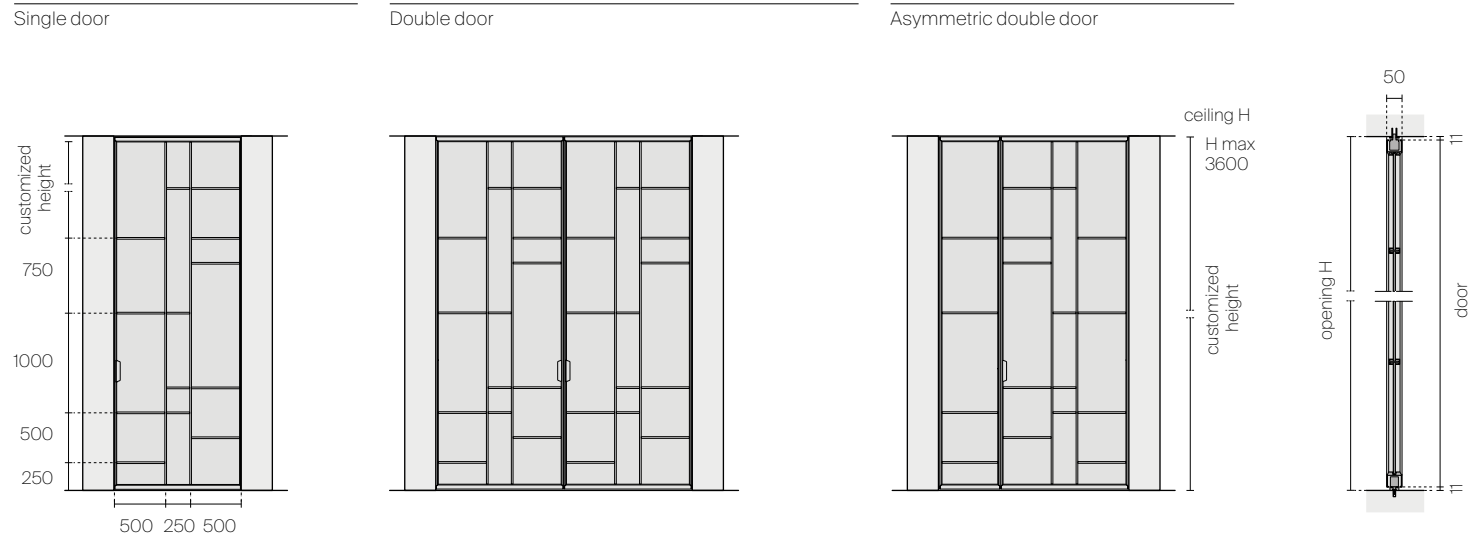

Air+

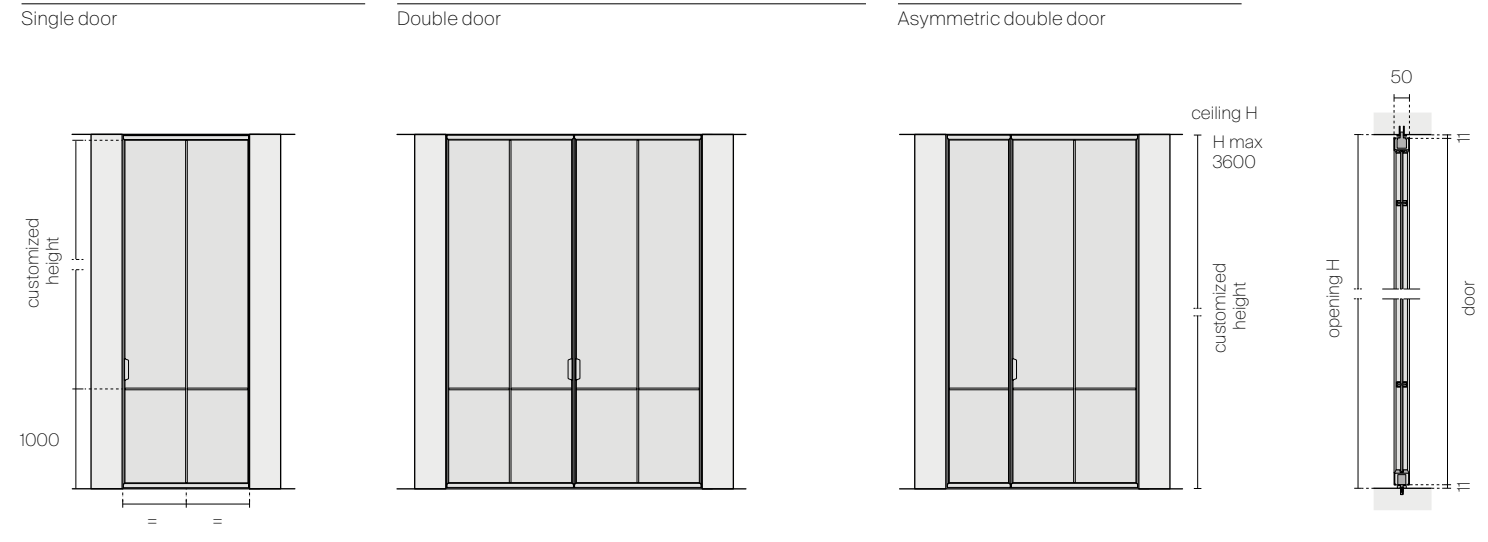

Air regular

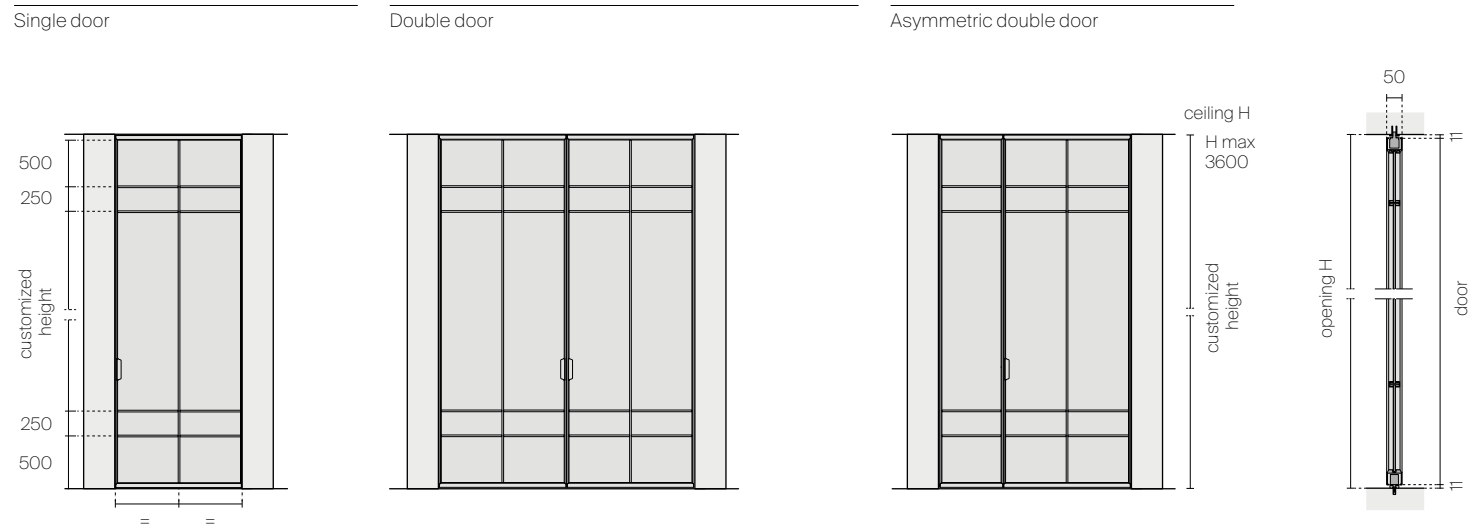

Air pure

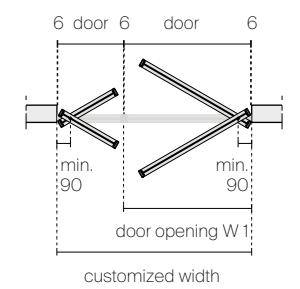
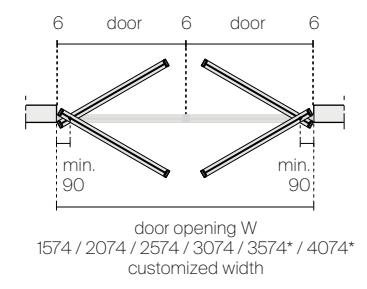
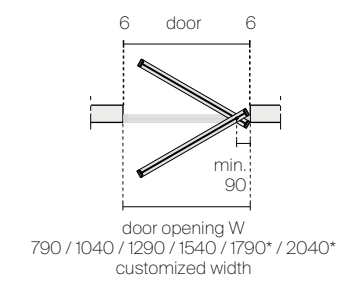
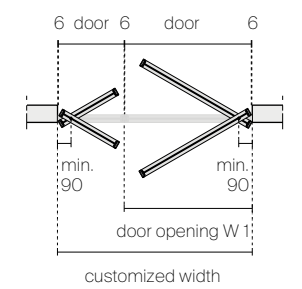
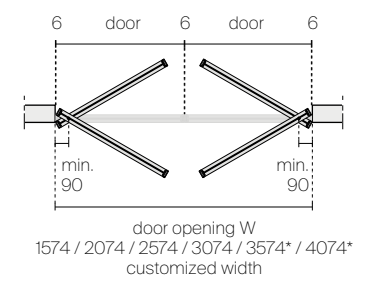
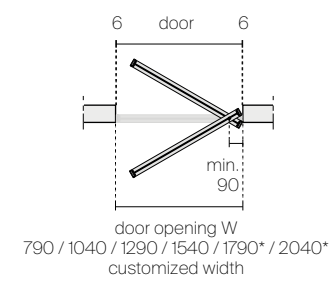
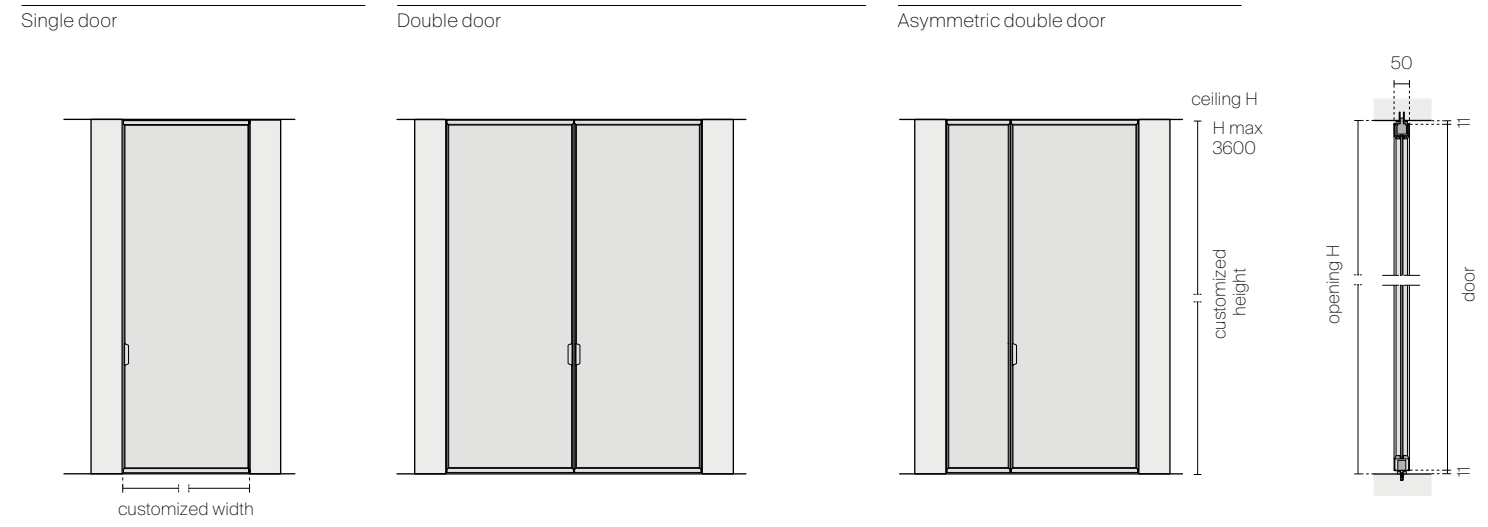

* available only for Air pure

* available only for Air pure

Air

Typology A: panel with single-coloured glass

Typology B: panel with two-tone glass

Typology C: panel with two-tone glass

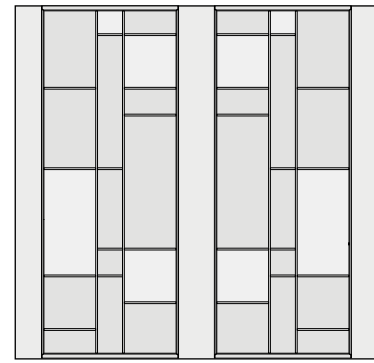
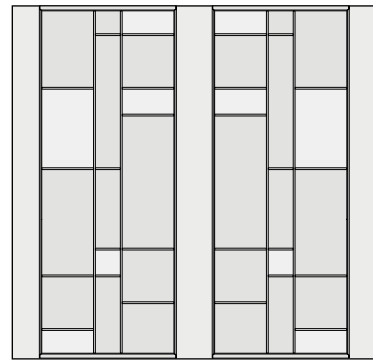
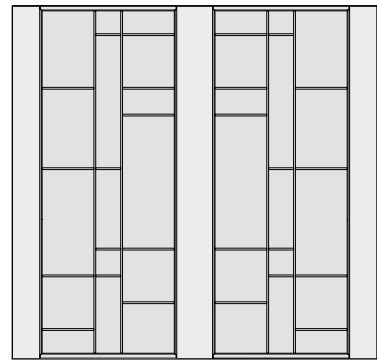

Air regular

Typology A: panel with single-coloured glass

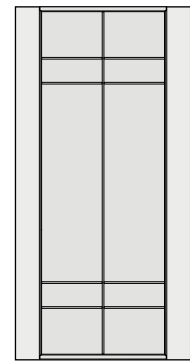

Typology B: panel with two-tone glass

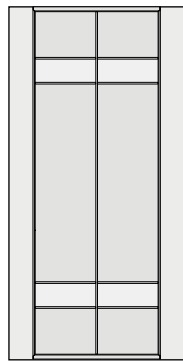

Air+

Panel with single-coloured glass

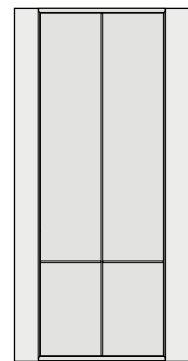

Air pure

Panel with single-coloured glass

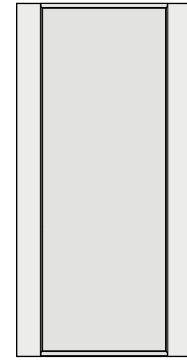

HANDLES

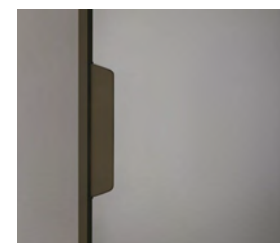
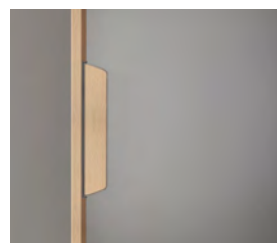

1

2

3

4

1. Handle in 304 platino and 711 rovere
2. Handle in 303 bronzo and 15 noce
3. Handle in 302 grafite and 19 rovere termotrattato
4. Handle in 14 brown
5. Handle in 303 bronzo
6. Handle in 302 grafite
7. Handle in 304 platino
8. Handle in 304 platino and 53 bianco neve

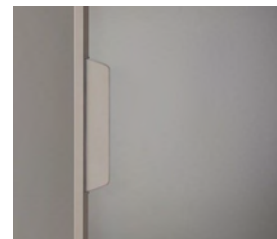
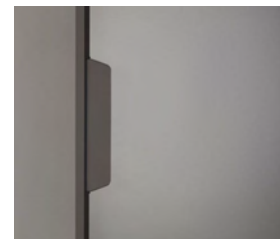
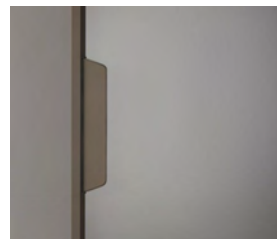

5

6

7

8

FINISHINGS

Air, Air regular, Air+ structure

ALUMINIUM



WOOD

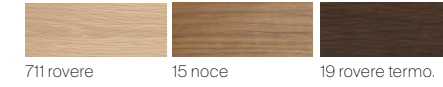

Air pure structure

MATT LACQUERED



LACQUERED METALIZED



ALUMINIUM



WOOD

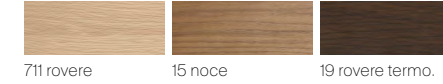

Handle

ALUMINIUM



WOOD

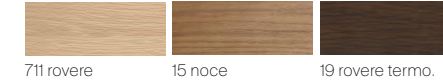

Glasses

LACQUERED GLASS



METALIZED GLASS



MESH GLASS



TRANSPARENT GLASS

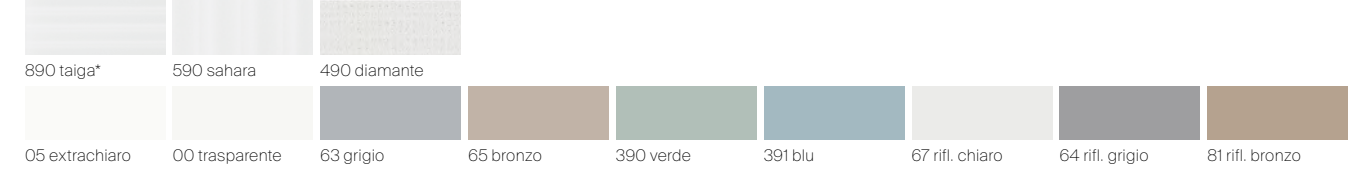

SATINATED GLASS



NEUTRAL GLASS



* not available for Air pure

QUALITY AS THE MAIN PURPOSE, ALWAYS AND IN EVERY ASPECT. WITH THIS MISSION RIMADESIO IS CONSTANTLY SEARCHING FOR SOLUTIONS TO IMPROVE ITS OWN ECOLOGICAL STANDARDS.

OBJECTIVE OBTAINED THANKS TO THE USE OF PRECIOUS AND RECYCLABLE MATERIALS, TO THE ABSENCE OF SUBSTANCES THAT CAN BE TOXIC TO HUMANS OR HARMFUL TO THE ENVIRONMENT IN EVERY PHASE OF THE PRODUCTIVE PROCESS, TO THE USE OF TECHNOLOGY AND EVOLVED MACHINERY, POWERED BY CLEAN ENERGY DERIVED FROM PHOTOVOLTAIC SYSTEMS, INSTALLED ON THE GIUSSANO HEADQUARTERS ROOF.

ALUMINIUM, GLASS, WOOD: FULLY RECYCLABLE AND PARTLY ALREADY RECYCLED MATERIALS.

PROOFS OF A REINFORCED GREEN DNA AND WIDE COHERENCE, SIGNALS OF A CONTINUOUS RESEARCH AND A GLANCE TOWARDS THE FUTURE, THAT TAKES SHAPE IN THE TECHNOLOGICAL INNOVATION OF SYSTEMS, DOORS AND FURNITURE, MADE WITH THE AWARENESS OF WANTING TO ENTRUST HUMANS ONLY WITH HIGH VALUE-ADDED ACTIVITIES.

EXCELLENCE SUSTAINABILITY PROJECT

IT Perseguire la qualità, sempre, sotto tutti gli aspetti. Con questa mission Rimadesio ricerca costantemente soluzioni volte a migliorare i propri standard qualitativi ecologici. Obiettivo ottenuto sinergicamente, grazie all'utilizzo di materiali preziosi e riciclabili, all'assenza di sostanze tossiche per l'uomo e nocive per l'ambiente in ogni fase del processo produttivo, all'impiego di tecnologie e macchinari evoluti alimentati con energia pulita proveniente da impianti fotovoltaici, installati sulla copertura dell'headquarter di Giussano. Alluminio, vetro, legno, materiali totalmente riciclabili e in parte già riciclati, ma anche le vernici prive di solventi di Ecoloursystem e i sistemi di imballaggio ecologici. Testimonianze di un dna green consolidato e di una coerenza trasversale, segnali di una continua attività di ricerca e di uno sguardo sempre proteso al futuro che si declina nell'innovazione tecnologica di sistemi, porte ed arredi, realizzati con la consapevolezza di voler affidare all'uomo solo attività dall'alto valore aggiunto.

DE Stets um Qualität bemüht, und zwar in allen Bereichen. Mit dieser Mission im Blick sucht Rimadesio laufend nach Lösungen, um seine ökologischen Qualitätsstandards zu verbessern. Dieses Ziel wurde dank der Verwendung wertvoller und wiederverwertbarer Materialien, dem Verzicht auf für den Menschen giftige und umweltschädliche Stoffe in jeder Phase des Produktionsprozesses und dem Einsatz fortschrittlicher Technologien und Maschinen, die mit sauberer Energie aus den auf dem Dach des Giussano-Hauptsitzes installierten Photovoltaikanlagen betrieben werden, synergetisch erreicht. Aluminium, Glas, Holz, vollständig recycelbare und teilweise bereits recycelte Materialien, aber auch die lösungsmittelfreien Farben von Ecoloursystem und umweltfreundliche Verpackungssysteme. Ein Zeugnis einer fundierten grünen DNA und einer transversalen Kohärenz, Zeichen einer kontinuierlichen Forschungstätigkeit und eines stets in die Zukunft gerichteten Blicks, der sich in der technologischen Innovation von Systemen, Türen und Einrichtungsgegenständen ausdrückt, die in dem Bewusstsein realisiert werden, den Menschen nur Tätigkeiten mit hohem Mehrwert anzuvertrauen.

FR Poursuivre la qualité, toujours, et à tous les égards. Avec cette mission Rimadesio recherche constamment de solutions au fin d'améliorer ses normes de qualité écologique. Objectif atteint, grâce à l'utilisation de matériaux précieux et recyclables, l'absence à chaque étape de la production de substances toxiques nocives pour l'homme et l'environnement, l'utilisation de technologies et des machines avancées alimentées par l'énergie solaire après l'installation sur le toit de l'usine à Giussano de systèmes photovoltaïques. Aluminium, verre, bois, des matériaux entièrement recyclables et déjà en partie recyclés, mais aussi peinture Ecoloursystem sans solvants et systèmes d'emballage respectueux de l'environnement. Témoignages d'un adn "vert" consolidé et d'une cohérence transversale, signes de recherche continue et d'une tendance à regarder en avant, qui correspond bien à l'innovation technologique des systèmes, des portes et des meubles, réalisés avec la conscience que l'apport de l'homme dans la production ne peut qu'avoir un valeur ajoutée.

ES Perseguir la calidad, siempre, en todos los aspectos. Con esta misión Rimadesio busca constantemente soluciones destinadas a mejorar sus estándares de calidad ecológica. Objetivo conseguido sinérgicamente, gracias al uso de materiales preciosos y reciclables, a la ausencia de sustancias tóxicas para los seres humanos y nocivas para el medio ambiente en cada etapa del proceso de producción, al uso de tecnologías y máquinas avanzadas alimentadas por energía limpia a partir de sistemas fotovoltaicos, instalados en la cobertura del headquarter de Giussano. Aluminio, cristal, madera, materiales completamente reciclables y, en parte, ya reciclados, sino también las pinturas Ecoloursystem libres de disolventes y los sistemas de embalaje ecológicos. Testimonios de un adn green consolidado y una coherencia transversal, señales de una continua investigación y de una vista siempre tendida al futuro que se declina en la innovación tecnológica de sistemas, puertas y muebles, realizados con el conocimiento que desea confiar al hombre sólo actividades de alto valor añadido.

RU Обеспечение качества всегда и во всем. И, в том числе, для достижения этой цели Компания Rimadesio находится в постоянном поиске решений, направленных на улучшение экологических стандартов качества. Эта цель была достигнута благодаря использованию на каждом этапе производственного процесса ценных материалов, пригодных для вторичной переработки, отсутствию токсичных для человека и вредных для окружающей среды веществ, а также благодаря внедрению передовых технологий и оборудования, работающего на чистой энергии от фотоэлектрических систем, установленных на крыше штаб-квартиры компании в г. Джуссано. Компания использует такие материалы, как алюминий, стекло, дерево – полностью перерабатываемые и уже частично переработанные материалы, краски Ecoloursystem, не содержащие растворителей, а также экологически упаковку. Свидетельство консолидированной экологичности и непрерывной последовательности, исследовательской деятельности и взгляда, всегда устремленного в будущее, что выражается в технологических инновациях систем, дверей и мебели, произведенных с осознанием того, что человеку стоит поручать только деятельность с высокой добавленной стоимостью.

汉语 始终至终追求全方位的卓越品质。Rimadesio 肩负使命，不断探索精进生态质量标准的解决方案。品牌目标之达成有赖于珍贵的可回收材料，该材料在所有制造阶段皆不会产生危害人体和环境之有毒物质，同时结合业界前沿的技术以及先进机械装置；而位于朱塞诺 (Giussano) 品牌总部建筑屋顶上的光伏发电设备为上述之机械装置供给干净的能源。除了可完全回收和已部分回收的铝材、玻璃、木材等材料之外，还有环保色彩系统 (Ecoloursystem) 的无溶剂涂料和生态环保型包装。深植的绿色 DNA、跨领域的协同性、持续的研究工作以及具前瞻性的未来展望皆体现在家具系统、各式门类 and 家具配件的技术创新上，其本着信赖人类才能胜任高附加价值活动的意念研发而成。

GUIDE TO RIMADESIO QUALITY

TEMPERED GLASSES

Single tempered glasses cooked at a temperature of 650 °C. Mechanical resistance 5 times superior in comparison to a normal glass. In case of breaking it crumbles in harmless tiny fragments. In accordance with the UNI EN 12150, UNI 7697 and UNI EN 12600 rules with reference to the security of glasses for decoration purposes.

LAMINATED GLASSES

Double glasses. Between the two glasses a thin plastic film is inserted. Transparent and invisible, it perfectly sticks to both surfaces. Both surfaces are perfectly smooth.Resistance to breaking in accordance with the UNI EN ISO 12543, UNI 7697 and UNI EN 12600 rules. The plastic film witholds the fragments in case of breaking.

GLASS WITH METAL NET AND MESH

Double laminated glasses. Between the two extra-clear glasses and two thin plastic films a micronet fabric is inserted. Through a sophisticated process a metal layer is applied on the fabric, thus creating a characteristic effect of semi transparency. The reflections of the light on the surface of the metallic net are provided by using an extra-clear float glass, which allows maximum transparency and high light transmissions, thanks to the low content of iron oxides. Following the process of hot stratification, the fabric might show minor wave effect, which give the material its characteristic materic and natural look.

ECOLORSYSTEM LACQUERED GLASSES Ecolorsystem is the name that distinguishes the exclusive Rimadesio lacquered glass collection in glossy and matt finishing. Ecological colours produced using exclusively water paints of latest generation, cooked at 110° C. A production technology in the area of glass, with a fully robotised in-house plant that ensures very high quality results and a low environmental impact work cycle. Corrosion resistance conforms to the UNI EN ISO 9227 standard. Temperature fluctuation resistance conforms to the UNI 9429 standard. The colour is inside the double glass, safe from stains, dust and humidity. The thickness of the glass creates an exclusive "depth" effect.

VETRI TEMPERATI

Vetri singoli, sottoposti al trattamento della tempra ovvero ad una cottura alla temperatura di 650 °C. Resistenza meccanica di 5 volte superiore rispetto ad un vetro normale. In caso di rottura si sbriciola in minuti frammenti inoffensivi. Conformi alle norme UNI EN 12150, UNI 7697 e UNI EN 12600 in materia di sicurezza per i vetri d'arredamento.

VETRI STRATIFICATI

Vetri doppi. Fra i due vetri è inserita una sottile pellicola di materiale plastico, trasparente ed invisibile, che aderisce completamente alle due superfici. Entrambe le superfici sono perfettamente lisce. Resistenza alla rottura conforme alle norme UNI EN ISO 12543, UNI 7697 e UNI EN 12600. La pellicola di materiale plastico in caso di rottura trattiene i frammenti.

VETRI STRATIFICATI RETE, MAGLIA E FIBRA

Vetri doppi stratificati. Tra i due vetri extra-chiari e le due sottili pellicole in materiale plastico, è inserito un tessuto in microrete sul quale, tramite un sofisticato processo di materizzazione, viene depositato uno strato metallico che crea un caratteristico effetto di semitrasparenza. Le riflessioni della luce sulla superficie della rete metallizzata sono ottenute con l'utilizzo del vetro float extrachiario che, grazie al basso contenuto di ossidi di ferro, garantisce la massima trasparenza e un'elevata trasmissione luminosa. Il tessuto, a seguito del processo di stratifica a caldo, può presentare delle leggere ondulazioni che conferiscono al materiale il suo caratteristico aspetto materico e naturale.

VETRI LACCATI ECOLORSYSTEM

Ecolorsystem è la denominazione che contraddistingue l'esclusiva collezione di vetri laccati Rimadesio, disponibili in finitura lucida e opaca. Colori ecologici perché prodotti utilizzando esclusivamente vernici all'acqua di ultima generazione, con cottura a 110°C. Una tecnologia produttiva all'avanguardia nell'ambito del vetro, con impianti interni totalmente robotizzati che assicurano risultati di altissima qualità e un ciclo di lavorazione a basso impatto ambientale. Resistenza alla corrosione conforme alla norma UNI EN ISO 9227. Resistenza agli sbalzi di temperatura conforme alla norma UNI 9429. Colori inalterabili nel tempo perché applicati sulla superficie interna del vetro, al sicuro da macchie, polvere e umidità. Lo spessore del vetro crea un esclusivo effetto di "profondità".

TEMPERIERTES GLAS

Einzelgläser, die einer Härtingsbehandlung oder einer Kochtemperatur von 650 °C unterzogen wurden. Mechanische Beständigkeit 5 mal höher als bei normalem Glas. Im Bruchfall zerbröckeln harmlose Bruchstücke in Minuten. Entspricht den Normen UNI EN 12150, UNI 7697 und UNI EN 12600 für die Sicherheit von Möbelgläser.

SCHICHTGLAS

Doppelgläser. Zwischen den beiden Gläsern befindet sich ein dünner Film aus transparentem und unsichtbarem Kunststoff, der vollständig an den beiden Oberflächen haftet. Beide Oberflächen sind komplett glatt. Die Bruchfestigkeit entspricht den Normen UNI EN ISO 12543, UNI 7697 und UNI EN 12600. Die Kunststoffolie bewahrt im Bruchfall die Bruchstücke.

SCHICHTGLAS MIT METALLNETZ, GLASGITTER UND FASER

Hierbei handelt es sich um Doppel-schichtgläser. Zwischen den zwei Extralight-Glasscheiben und den beiden unsichtbaren Plastikfolien wird ein Metall-netz eingesetzt. Das kreiert einen besonderen halbtransparenten Effekt. Der Wiederschein des Lichtes auf der Oberfläche des Metallnetzes wird durch die Verwendung von Extralight Float Glas erzielt. Dank eines kleinen Anteils von Eisenoxid haben wir die maximale Lichtdurchlässigkeit und eine sehr hohe Lichtübertragung erzielen können. Das Netz kann nach dem unter Hitze durchgeführten Schichtungsverfahren leichte Welle aufweisen, was dem Material ein natürliches Aussehen verleiht.

LACKIERTE GLÄSER ECOLORSYSTEM

Ecolosystem ist der Name der lackierten Glas-Kollektion von Rimadesio in der glänzend und matte Ausführung verfügbar. Absolut oekologische Farben, da die modernsten Lackierungen, auf Wasser-Basis, an einer Temperatur von 110° gekocht werden. Eine fortschrittliche Produktionstechnik in der Glasverarbeitung auf einer vollautomatisierten Anlage, die Ergebnisse höchster Qualität und gleichzeitig umweltfreundliche Verarbeitungsverfahren gewährleistet. Korrosion-sprüfung gemäß Bestimmung UNI EN ISO 9227. Temperaturwechselprüfung gemäß Bestimmung UNI 9429. Unverändliche Farben da die Farbung sich im Innen des Doppelglases, geschützt vor Staub, Kratzen und Feuchtigkeit, befindet. Die Dicke des Glases erzeugt eine einzigartige Tiefwirkung.

VERRES TREMPÉS

Verres simples, soumis au traitement de trempe et donc à une température de cuisson de 650 °C. Résistance mécanique 5 fois supérieure à celle du verre normal. En cas de rupture, des fragments inoffensifs s'effritent en quelques minutes. Conforme aux normes UNI EN 12150, UNI 7697 et UNI EN 12600 pour la sécurité des verres pour les meubles.

VERRES STRATIFIÉS

Double verres. Entre les deux verres se trouve une fine pellicule de matière plastique, transparente et invisible, qui adhère complètement aux deux surfaces. Les deux surfaces sont parfaitement lisses. La résistance aux ruptures est conforme aux normes UNI EN ISO 12543, UNI 7697 et UNI EN 12600. La pellicule retient les fragments en cas de rupture.

VERRE FEUILLETÉ AVEC NET, MAILLE ET FIBRA

Double verre stratifié. Entre les deux verres extra clair et les deux films fins de matière plastique un tissu en micro maille est ajouté. A travers un procédé avancé de materisation un couche métallique est déposé sur ce tissu, créant un effet caractéristique translucide. Les reflets de la lumière sur la surface de la maille métallique sont obtenus avec l'utilisation du verre float extra clair, qui, grâce à un faible teneur de oxydes de fer, permet un maximum de transparence et de transmission de la lumière. Suite au procédé de stratification à chaud, le tissu peut présenter de petites ondulations, qui apportent au matériau son aspect caractéristique et naturel.

VERRES LAQUÉS ECOLORSYSTEM

Ecolorsystem est le nom qui caractérise la collection exclusive de verres laqués de Rimadesio disponibles en finition brillante et mate. Couleurs écologiques, parce que produits en utilisant exclusivement vernis à l'eau de dernière génération, cuites à 110°. Une technologie de production avant-gardiste dans le domaine du verre, avec des équipements internes entièrement robotisés qui assurent des résultats de grande qualité et un cycle de production ayant un impact très faible sur l'environnement. Résistance à la corrosion conformément à la norme UNI EN ISO 9227. Résistance aux écarts de température conformément à la norme UNI 9429. Couleurs inaltérables parce qu'ils sont appliqués dans la surface interne du verre, pour protéger de la poussière humidité et taches. L'épaisseur du verre crée un exclusif effet profondeur.

CRISTALES TEMPLADOS

Vidrios simples, sometidos al tratamiento de templado a una temperatura de cocción de 650 °C. Resistencia mecánica de 5 veces mayor que el vidrio normal. En caso de rotura, se desmoronan fragmentos inofensivos. Conforme a las normas UNI EN 12150, UNI 7697 y UNI EN 12600 en materia de seguridad para los cristales en el amueblamiento.

CRISTALES ESTRATIFICADO

Vidrios dobles. Entre los dos vidrios hay una película fina de material plástico, transparente e invisible, que se adhiere completamente a las dos superficies. Ambas superficies son perfectamente lisas. La resistencia a la rotura cumple con las normas UNI EN ISO 12543, UNI 7697 y UNI EN 12600. La película de plástico en caso de rotura retiene los fragmentos.

CRISTALES ESTRATIFICADOS RED METÁLICA, MAILLA Y FIBRA

Cristales dobles estratificados. Entre los dos cristales extraclaros y las dos capas sintéticas, está inserido en un tejido de microred en el que, a través de un sofisticado proceso se deposita una característica de efecto semitransparente. Los reflejos de la luz sobre la superficie de la red metálica se proporcionan con el uso del vidrio float extraclaro que, gracias a su bajo contenido en óxidos de hierro, asegura la máxima transparencia y una alta transmisión de luz. El tejido, siguiendo el proceso de estratificación en caliente, puede presentar ligeras ondulaciones que dan al material su aspecto característico natural.

CRISTALES LACADOS ECOLORSYSTEM

Ecolorsystem es la denominación que marca la exclusiva colección de los cristales lacados Rimadesio, disponibles en acabado brillante y mate. Colores ecológicos porque productos utilizando exclusivamente pinturas al agua de última generación, con cocción a 110°. Una tecnología productiva a la vanguardia en el ámbito del cristal, con unas instalaciones internas totalmente robotizadas que aseguran resultados de altísima calidad y un ciclo de tratamiento respetuoso del medio ambiente. Resistencia a la corrosión conforme a la norma UNI EN ISO 9227. Resistencia a las variaciones de temperatura conforme a la norma UNI 9429. Colores inalterables en el tiempo porque aplicados en la superficie interior del cristal, al resguardo de manchas, polvo y humedad. El grosor del cristal crea un exclusivo efecto de "profundidad".

ЗАКАЛЕННОЕ СТЕКЛО

Механическая прочность одинарных стекол, подвергнутых закалке, т.е. обжигу при температуре 650°С, в 5 раз выше, чем у обычного стекла. Если такое стекло разбить, оно рассыпется на мелкие неопасные осколки. Соответствует стандартам безопасности UNI EN 12150, UNI 7697 и UNI EN 12600 для мебельного стекла.

МНОГОСЛОЙНОЕ СТЕКЛО

Двойные стекла. Тонкая, прозрачная и невидимая пластиковая пленка прокладывается между двумя стеклами и полностью приклеивается к обеим поверхностям. Обе поверхности идеально гладкие. Проверка прочности на разрыв была выполнена в соответствии со стандартами UNI EN ISO 12543, UNI 7697 и UNI EN 12600. Эта пленка способна удерживать осколки разбившегося стекла.

МНОГОСЛОЙНОЕ СТЕКЛО, СТЕКЛО С СЕТКОЙ

Многослойное двойное стекло. Между двумя сверхпрозрачными стеклами и двумя тонкими пластиковыми пленками вставляется микросетчатое полотно, на которое в ходе сложного производственного процесса наносится металлический слой, благодаря чему и формируется характерный полупрозрачный эффект. Отражение света на поверхности металлизированной сетки достигается за счет использования сверхчистого флот-стекла, которое из-за низкого содержания оксида железа гарантирует максимальную прозрачность и высокую светопропускную способность. В результате процесса наслаивания в горячем виде полотно приобретает небольшие волнистости, которые придают материалу характерную текстуру и натуральный вид.

ЛАКИРОВАННОЕ СТЕКЛО

ECOLORSYSTEM Ecolorsystem — это название эксклюзивной коллекции лакированного стекла Rimadesio, доступной в глянце-вой и матовой отделке. Коллекция характеризуется мягкими спокойными цветами, поскольку при их производстве используются только краски последнего поколения на водной основе, запекаемые при температуре 110°С. В стекольной промышленности в настоящее время внедряются современные производственные технологии, полностью роботизированные заводы, обеспечивающие высокое качество и незначительное воздействие на окружающую среду. Коррозионная стойкость соответствует требованиям положений стандарта EN ISO 9227. Устойчивость к изменениям температуры соответствует требованиям стандарта UNI 9429. Цвет характеризуется исключительной долговечностью, поскольку краски наносятся на внутреннюю поверхность стекла, защищенную от пятен, пыли и влаги. Толщина стекла создает уникальный эффект «глубины».

钢化玻璃 单片玻璃通过淬火工艺,即经 650 °C 高温烧制而成,其机械阻力相较于普通玻璃高出 5 倍。钢化玻璃破裂时会碎成不易伤人的细小碎片。符合家具玻璃安全材质 UNI EN 12150、UNI 7697 以及 UNI EN 12600 的标准。

夹层玻璃

双层玻璃。在两片玻璃之间夹有一层纤薄、透明、无形的塑料薄膜,其完全贴合两片玻璃的表面。两片玻璃的表面皆光滑无比。其抗裂性能符合 UNI EN ISO 12543、UNI 7697 以及 UNI EN 12600 的标准。玻璃破裂时,其碎片会粘在塑料薄膜上,裂而不散。

网夹层玻璃、网格夹层玻璃和纤维夹层玻璃 双层夹层玻璃。在两片超清玻璃和两层纤薄的塑料薄膜之间夹入一层微型网状织物,一道细腻的材质加工工艺,会在织物上覆盖一层金属并创造出半透明的特殊效果。使用超清浮法玻璃产出金属网表面的光线反射,因玻璃的氧化铁含量低,可确保最大透明度和高透光率。通过热分层加工工艺,夹入的织物会有不平整的现象,从而呈现出具有特色的材质纹理和自然感的外观。

环保色彩系统 (Ecolorsystem) 的烤漆玻璃 Ecolorsystem 为 Rimadesio 烤漆玻璃独家系列的名称,有亮面和哑光两种表面处理可供选择。由于仅使用最新一代的水性涂料搭配 110°C 烘烤工序完成而被称为生态环保性色彩;其为超前玻璃业界的生产技术,而全机器人化的内部设备确保极高的产品质量和低环境冲击的加工循环。其抗腐蚀程度符合 UNI EN ISO 9227 的标准。其抗温度急变性符合 UNI 9429 的标准。因色彩涂层夹于玻璃内层,因此不会褪色且不受脏污、灰尘和湿气的影响。玻璃的厚度创造出一种独特的“深度”效果。

ECOLORSYSTEM LACQUERED GLASS

GLOSSY MATT		GLOSSY MATT		GLOSSY MATT		GLOSSY MATT		GLOSSY MATT		GLOSSY MATT			
305	138 cipria	45	97 avorio	59	105 grigio chiaro	40	115 grigio cenere	53	95 bianco neve	50	108 bianco latte		
51	113 nocciola	52	107 corda	56	98 lino	312	145 grigio seta	47	96 grigio perla	78	114 sabbia		
306	139 terracotta	85	130 tufo	310	143 creta	38	121 azzurro cera	36	117 blu Londra	74	110 canapa		
76	116 rosso india	308	141 pepe	317	600 grigio artico	35	100 blu notte	39	122 verde inglese	73	109 giallo kashmir		
75	129 amaranto	309	142 sandalo	88	132 grigio scuro	86	131 blu oceano	314	147 verde lichene	43	119 laguna		
307	140 java	58	99 caffè	311	144 grigio lava	313	146 blu scuro	315	148 verde scuro	33	111 verde oliva		
		84	128 moro	46	102 nero					316	149 verde terra		

ECOLORSYSTEM SAHARA GLASS

551	nocciola sahara	552	corda sahara	517	lino sahara	512	grigio seta sahara	514	verde lichene sahara	574	canapa sahara
506	terracotta sahara	508	pepe sahara	524	grigio artico sahara	522	blu oceano sahara	515	verde scuro sahara	543	laguna sahara
507	amaranto sahara	509	sandalo sahara	521	grigio scuro sahara	513	blu scuro sahara			523	verde oliva sahara
540	java sahara	519	caffè sahara	511	grigio lava sahara						
		584	moro sahara	546	nero sahara						

ECOLORSYSTEM TAIGA GLASS

851	nocciola taiga	852	corda taiga	817	lino taiga	812	grigio seta taiga	814	verde lichene taiga	874	canapa taiga
806	terracotta taiga	808	pepe taiga	824	grigio artico taiga	822	blu oceano taiga	815	verde scuro taiga	843	laguna taiga
807	amaranto taiga	809	sandalo taiga	821	grigio scuro taiga	813	blu scuro taiga			823	verde oliva taiga
840	java taiga	819	caffè taiga	811	grigio lava taiga						
		884	moro taiga	846	nero taiga						

ECOLORSYSTEM METALIZED GLASS

GLOSSY MATT		SAHARA		TAIGA		DIAMANTE	
304	137 platino	504	platino sahara	804	platino taiga	404	platino diamante
69	126 palladio	569	palladio sahara	869	palladio taiga	469	palladio diamante
83	127 piombo	583	piombo sahara	883	piombo taiga	483	piombo diamante
301	134 peltro	501	peltro sahara	801	peltro taiga	401	peltro diamante
302	135 grafite	502	grafite sahara	802	grafite taiga	402	grafite diamante
303	136 bronzo	503	bronzo sahara	803	bronzo taiga	403	bronzo diamante
300	133 rame	500	rame sahara	800	rame taiga	400	rame diamante

NEUTRAL GLASS

55	specchio
68	specchio grigio

TRANSPARENT GLASS

890	trasparente taiga
590	trasparente sahara
490	trasparente diamante
05	trasparente extrachiaro
00	trasparente
63	grigio trasparente
65	bronzo trasparente
390	verde trasparente
391	blu trasparente

SATINATED GLASS

67	riflettente chiaro
64	riflettente grigio
81	riflettente bronzo
891	acidato taiga
591	acidato sahara
02	acidato extrachiaro
01	acidato
03	acidato grigio
04	acidato bronzo
82	nuvola extrachiaro
80	nuvola

MESH GLASS

60	rete alluminio
61	rete inox
62	rete bronzo
66	maglia gold
87	maglia rame
06	fibra argento
08	fibra bronzo





REFLEX GLASS

90	bianco reflex
92	kaki reflex
94	cacao reflex
89	nero reflex





ECOLORSYSTEM MATT LACQUERED

 305 cipria	 45 avorio	 59 grigio chiaro	 40 grigio cenere	 53 bianco neve	 16 bianco latte
 51 nocciola	 52 corda	 56 lino	 312 grigio seta	 47 grigio perla	 78 sabbia
 306 terracotta	 85 tufo	 310 creta	 38 azzurro cera	 36 blu Londra	 74 canapa
 76 rosso india	 308 pepe	 317 grigio artico	 35 blu notte	 39 verde inglese	 73 giallo kashmir
 75 amaranto	 309 sandalo	 88 grigio scuro	 86 blu oceano	 314 verde lichene	 43 laguna
 307 java	 58 caffè	 311 grigio lava	 313 blu scuro	 315 verde scuro	 33 verde oliva
	 84 moro	 13 nero			 316 verde terra

ECOLORSYSTEM LACQUERED METALIZED

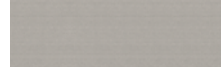
 304 platino	 302 grafite
 69 palladio	 303 bronzo
 83 piombo	 300 rame
 301 petro	

ALUMINIUM

 31 alluminio lucido
 30 alluminio
 14 brown
 318 nickel grigio
 22 nero lucido

LEATHER

 C23 bianco ghiaccio
 C17 sand
 C29 toupè
 C22 caramello
 C28 fango
 C11 moka

SYNTHETIC LEATHER

 157 arena
 158 agata
 155 nube
 154 argilla
 160 miele
 153 castoro
 159 etna
 156 rubens









LUX FABRIC

 T006 gesso
 T052 segale
 T044 acciaio
 T012 marmotta
 T042 ruggine
 T051 salvia

MATERIAL FABRIC

 T020 nebbia
 T019 papiro
 T009 piuma
 T017 roccia
 T001 terracotta
 T003 brandy
 T018 tabacco

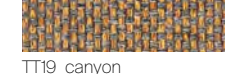







TECH FABRIC

 TT01 duna
 TT03 tortora
 TT05 mosto
 TT07 antracite
 TT09 fumo
 TT10 ghiaccio
 TT11 giada
 TT19 canyon
 TT20 dolomiti
 TT21 cedro

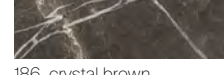
RAFIA

 T133 magnolia
 T134 desert
 T101 natural
 T115 stone
 T102 sequoia

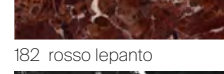
MARBLE

 28 calacatta
 188 sierra beige
 184 crystal grey
 186 crystal brown
 180 emperador
 183 noir saint laurent
 187 verde lepanto
 182 rosso lepanto
 181 nero marquinia



MATT MARBLE

 198 calacatta opaco
 194 crystal grey opaco
 191 nero marquinia opaco
 185 crystal white opaco

LITECH

 G001 crema
 G002 moka
 G003 piedra
 G004 grigio rigato

WOOD

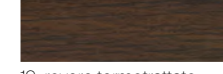
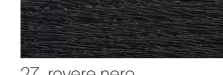
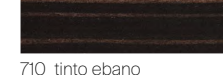
 711 rovere
 15 noce
 19 rovere termotrattato
 27 rovere nero
 710 tinto ebano

TAIGA WOOD

 701 rovere taiga
 700 tinto ebano taiga

SAHARA WOOD

 17 noce sahara
 20 rovere termotrattato sahara

MELAMINE

 07 melaminico olmo
 09 melaminico rovere grigio
 25 melaminico larice carbone

INTERNAL MELAMINE

 UB07 mel. cuoio grigio
 UB09 mel. cuoio brown

Collection designed by Giuseppe Bavuso.

Art direction and graphic project: Juma
Photo: Federico Cedrone, Santi Caleca
Technical photo: F2 Fotografia
Styling: Studiopepe; Patrizia Cantarella with Rossella Ballabio;
Martina Lucatelli with Martina Dalla Bona;
Simona Silenzi Studio; Gaia Marchesini and Giordano Sarno.

Thanks to: Afolki, Agape, Ames, Amini Carpets, aponteboretti, Arnolfo di Cambio, Artemide, Astep, AYTM, Azucena, B&B Italia, Baxter, Bitossi Ceramiche, Brionvega, Carl Hansen & Søn, Claire Lune, Cooeee Design, Danese Milano, Dany GILLES, Davide Groppi, De Vecchi Milano 1935, Dechem Studio, Dep Art Gallery, Egidio Milesi, Emil, Etel Milano, Flexform, Flos, FontanaArte, FPM Milano, Fritz Hansen, Gan Rugs, Gardeco, Gervasoni 1882, Henry Timi, Ittala, Ivano Redaelli, Iwata Mokku, J. & L. Lobmeyr, Knoll, Lanerossi, Lindell & Co, Living Divani, Lorenzo Franceschinis, Louis Poulsen, Maru Gallery, Matteo Thun Atelier, distributed by Manus Factor, Maxalto, Nemo Lighting, Noorstad, Noorth, Nude Glass, NUMA Limited Editions, Nuove Forme, Officine Saffi, Oluce, Pallucco, Phantom Hands, Raawi, Rains, Raumgestalt, Riva 1920, Scandola marmi, Serafino Zani, Skagerak, Society, STELTON distribuito da Schönhuber Spa, Suede, Tacchini, Terry Davies Ceramics, Unurgent Argilla, Up To You Anthology, Vitra, When Objects Work.

Films and print: Optima
Printed in Italy, 2024

RIMADESIO SPA
Via Furlanelli 96
20833 Giuszano (MB) Italy
T +39 0362 3171
rimadesio@rimadesio.it

MILANO FLAGSHIP STORE
Via Visconti di Modrone 26
20122 Milano Italy
T +39 02 76280708
milano@rimadesio.it

LONDON FLAGSHIP STORE
83-85, Wigmore street
1WU 1DL London
T +44 2074 862193
london@rimadesio.co.uk

NEW YORK FLAGSHIP STORE
102 Madison Ave
New York, NY 10016
T +1 917 388 2650
usa@rimadesio.us

www.rimadesio.it

AWARDS

1993	Siparium	Young & Design
2000	Zenit	Award KBB
2001	Zenit	selection Design Index ADI
2002	Siparium	Top100 Frames
2005	Graphis	selection Design Index ADI
2007	Vela	selection Design Index ADI
2008	Vela	mention XXI Premio Compasso d'Oro ADI
2015	Wind	winner Red Dot Award
2016	Cover	Best Furniture System AZ Award
2016	Alambra	selection Design Index ADI
2017	Sail	selection Design Index ADI
2017	Soho	Architectural products AZ awards
2017	Daimon	Interior Design Magazine Best of Year awards
2020	Modulor	People's Choice winner AZ Awards
2020	Modulor	Architectural Products Award of Merit AZ Awards
2020	Modulor	selection Design Index ADI
2021	Francis	selection Design Index ADI
2021	Modulor	LivingEtc Style Awards
2022	Maxi	selection Design Index ADI
2022	Aliante	finalist Interior's best of the Year awards
2022	Aliante	finalist A+Product awards
2023	Maxi	winner German Design Awards
2023	Radius	Architect's Newspaper's Best of Products Awards

PATENTED:

Air, Radius, Aliante, Rialto, Maxi, Sail, Soho, Velaria, Stripe, Daimon, Graphis, Zen, Zen frame, Siparium, Moon, Vela, Luxor, Even, Aura, Spin, Link+, Planet, Flat, Alambra, Abacus living, Self, Cover, Zenit, Dress bold, Abacus.

REGISTERED TRADEMARKS:

Rimadesio, Colorsystem, Litech, Siparium, Velaria, Abacus.



Follow us on Instagram, Facebook, LinkedIn,
WeChat, Weibo, Little Red Book.

